

# KELOX<sub>FB</sub>

KU590E ULTRA PE-RT industrial surface manifold pipe 6/4" 8 L:780mm

7964080

## Areas of application



Stainless steel flow and return flow bar (6/4"), with bleeding and emptying at the manifold end, connections with pre-formed 6/4" flat-sealing cap nut. On the feed line ball valve, 3/4" non-porous metallised brass with euro cone male thread; on the return line thermostatic valve for setting the water amount, heating circuit outlets 3/4" euro cone with male thread, return flow valve bonnets to fit KM596 KELOX thermal motor including soundproofed steel consoles

Area of application: tmax. 80°C/6 bar

ATTENTION: WITHOUT KM220 Euro thread fitting!

# Specifications

## Article information

extendible 0

## Product information

VPE1	1,00 KT1
VPE2	16,00 PAL
weight	8,310 KGM
text	ULTRA PE-RT industrial surface manifold pipe 6/4"
INTRNR	84818039
code	KU590E

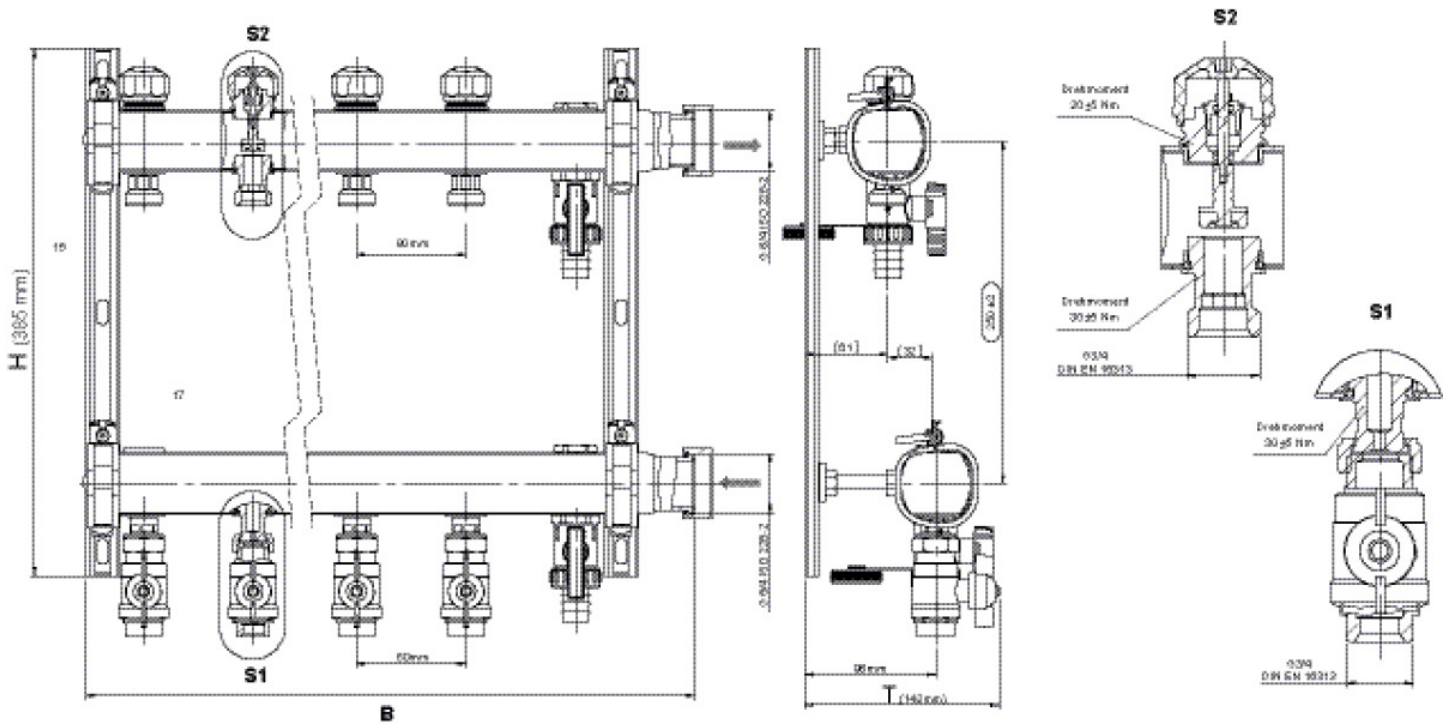

Art. No	label	t mm	t mm	h mm
7964080	8 L:780mm	142	770	385



**KE KELIT GmbH**

A 4020 Linz, Ignaz-Mayer-Straße 17, Austria, Europe

**PHONE** +43 (0) 50 779 **E-MAIL** [office@kekelit.com](mailto:office@kekelit.com)

[www.kekelit.com](http://www.kekelit.com)