

KELOX_{FB}

KU590E ULTRA PE-RT industrial surface manifold pipe 6/4" 9 L:860mm

7964090

Areas of application



Stainless steel flow and return flow bar (6/4"), with bleeding and emptying at the manifold end, connections with pre-formed 6/4" flat-sealing cap nut. On the feed line ball valve, 3/4" non-porous metallised brass with euro cone male thread; on the return line thermostatic valve for setting the water amount, heating circuit outlets 3/4" euro cone with male thread, return flow valve bonnets to fit KM596 KELOX thermal motor including soundproofed steel consoles

Area of application: tmax. 80°C/6 bar

ATTENTION: WITHOUT KM220 Euro thread fitting!

Specifications

Article information

extendible 0

Product information

VPE1	1,00 KT1
VPE2	16,00 PAL
weight	9,090 KGM
text	ULTRA PE-RT industrial surface manifold pipe 6/4"
INTRNR	84818039
code	KU590E

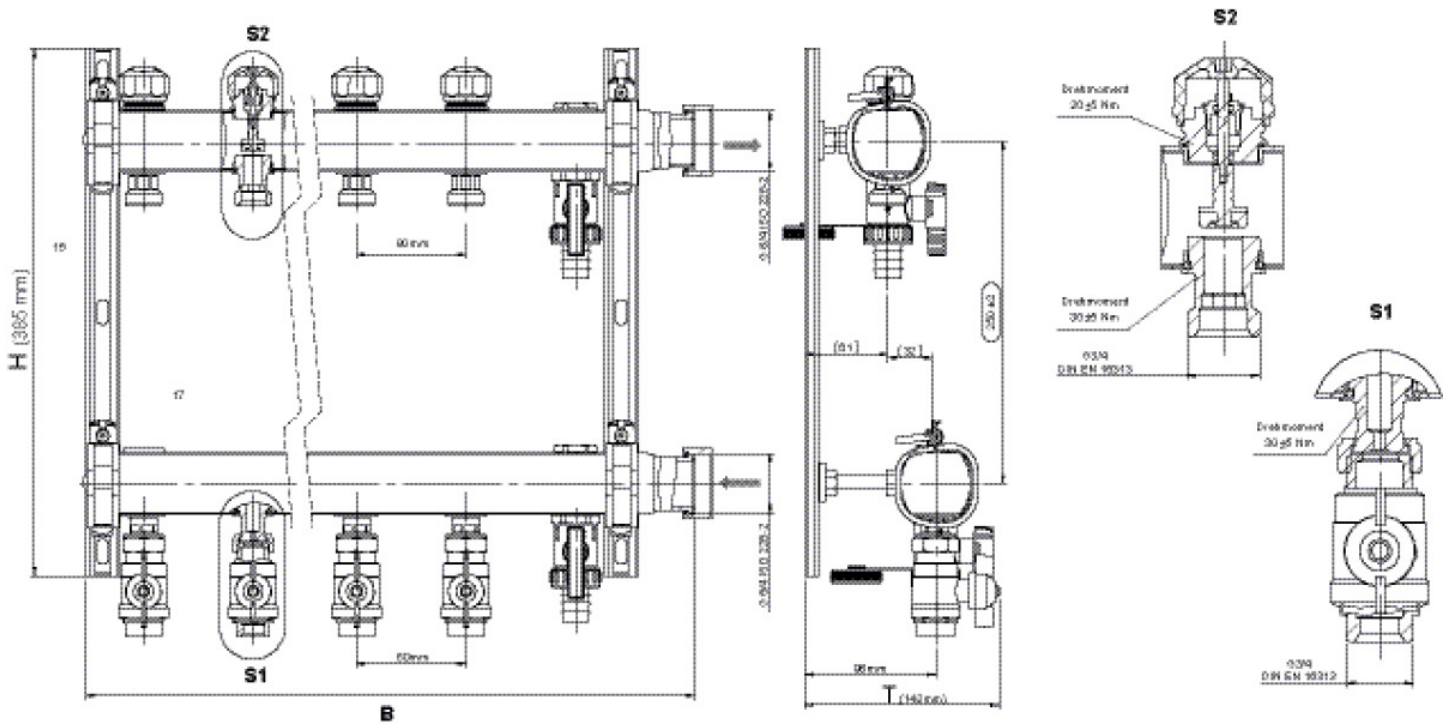

Art. No	label	t mm	t mm	h mm
7964090	9 L:860mm	142	850	385



KE KELIT GmbH

A 4020 Linz, Ignaz-Mayer-Straße 17, Austria, Europe

PHONE +43 (0) 50 779 **E-MAIL** office@kekelit.com

www.kekelit.com