

KELOX

KM138 KELOX Lambda Plus pipe 20 20x2.25

75212018

Areas of application



?KELOX multilayer pipe conforming to ÖNORM EN ISO 21003, oxygen- and water vapour diffusion-tight 5-layer PE-RT/Al/PE-RT composite pipe, with factory-applied 16mm closed-cell soft foam insulation and jacket made of viscoplastic PE film

Classification of operating conditions according to ÖNORM EN ISO 21003

Sanitary application - Class 2: 70°C - tmax 80°C/10 bar

Radiator connection - Class 5: 80°C - tmax 90°C/10 bar

Based on the improved insulation material quality, the KELOX Lambda Plus pipe 20 according to ÖNORM H5155 corresponds to an insulation thickness of 20mm with corresponding conversion.

Lambda Plus heat conductivity - insulation 0.031 W/mK at 10°C

Lambda Plus thermal conductivity - insulation 0.035 W/mK at 50°C

Insulation thickness: 16mm corresponds to 20mm according to ÖNORM H5155

Colour: silver

Supplied in coils

Approvals:



Specifications

Product information

VPE1	50,00 ROL
VPE2	500,00 PAL
L	50
weight	0,276 KGM
text	KELOX Lambda Plus pipe 20
INTRNR	39173900
main material group	KELOX
material group	KELOX isolierte pipes
code	KM138

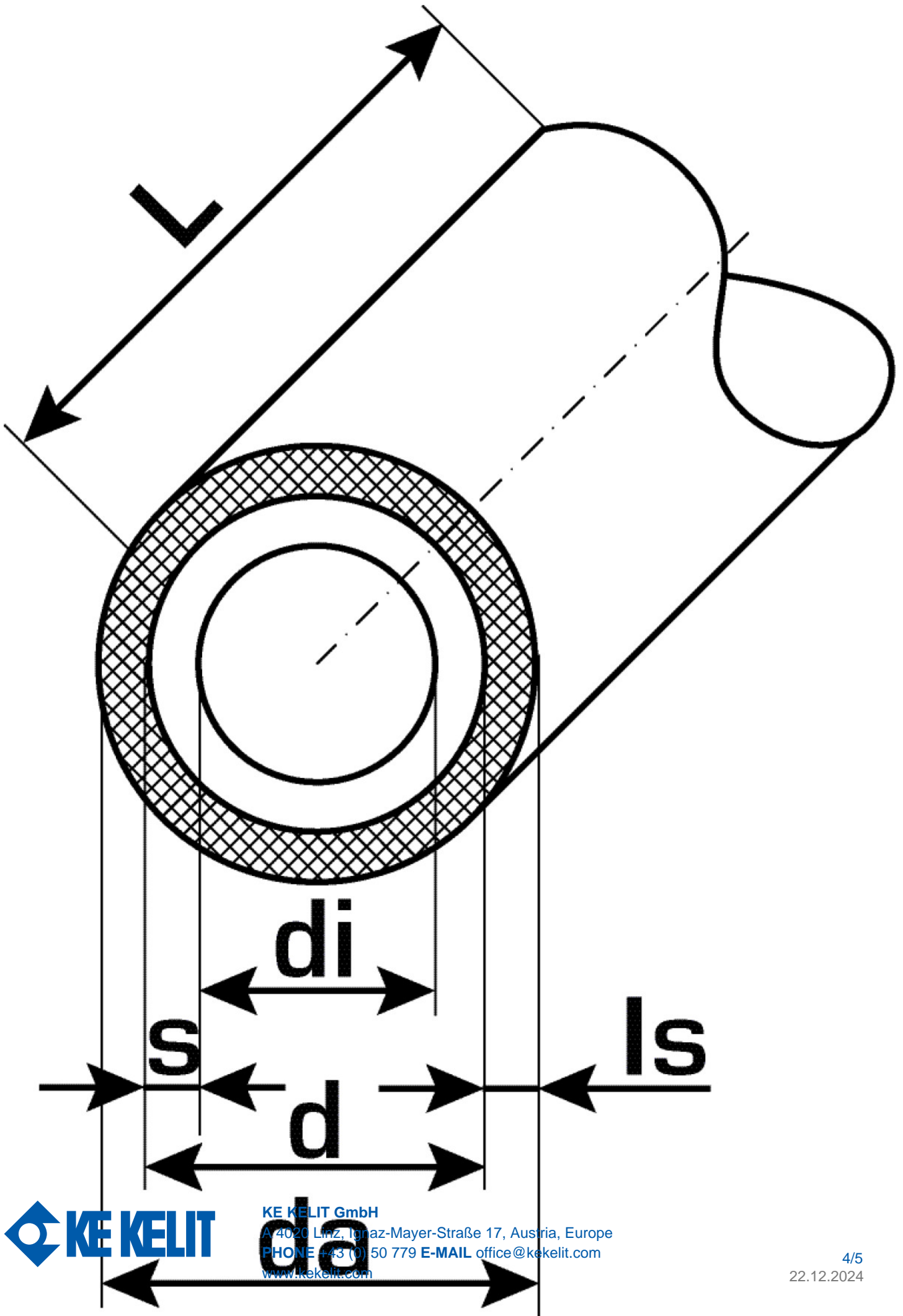

Art. No	label
75212018	20x2.25



KE KELIT GmbH
A 4020 Linz, Ignaz-Mayer-Straße 17, Austria, Europe
PHONE +43 (0) 50 779 **E-MAIL** office@kekelit.com
www.kekelit.com