

KELOX

KMP451X KELOX-PROTEC CLIX union with male thread 20x1/2"

730241D02

Areas of application

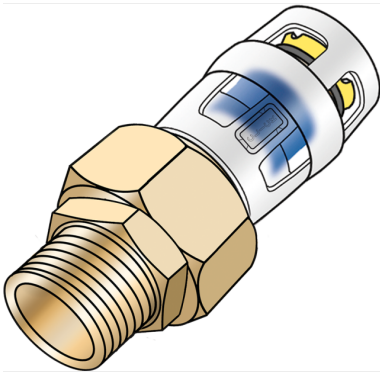

Plug-in union with male thread made from stainless steel, thread conforms to ÖNORM EN 10226, for connection to fittings, made of dezincification-resistant brass (DZR), including push-on sleeve made of transparent polyamide with insertion click noise, as well as haptic and optical insertion indicator, O-rings, withdrawal barriers and protector ring as insertion locking device, flat-sealing incl. seal

Approvals:



Specifications

Article information

port 1	Plug-in
port 2	Male thread metric
design	Miscellaneous

Technical properties

maximum working pressure at 20 ° C	10 bar
------------------------------------	--------

Product information

VPE1	10,00 SA1
VPE2	100,00 KT1
weight	0,134 KGM
text	KELOX-PROTEC CLIX union with male thread
INTRNR	74122000
main material group	KELOX
material group	KELOX-PROtec pushfittings
code	KMP451X



Art. No	label	d2 Zoll	d1 mm	L1 mm	z1 mm	z2 mm	slw1 mm	slw2 mm
730241D02	20x1/2"	1/2 Zoll (15)	20	50,5	14,5	33	30	25