

KELOX

KMP480X KELOX-PROTEC CLIX wall bracket fitting with female thread 20x3/4"

730250D04

Areas of application

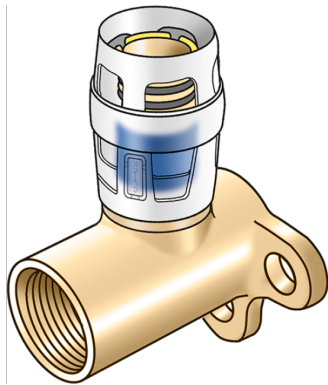

Plug-in wall bracket fitting with female thread, made of dezincification-resistant (DZR) brass, incl. push-on sleeve made of transparent polyamide with insertion click noise, as well as haptic and optical insertion indicator, O-rings, withdrawal barriers and a protector ring as an insertion locking device

Overall height:

1/2" - 47mm

3/4" - 49mm

DO NOT screw in any threaded pipes and cast iron fittings!

Approvals:



Specifications

Article information

port 1	Plug-in
design	Continuously right-angled

Technical properties

maximum working pressure at 20 ° C	10 bar
------------------------------------	--------

Product information

VPE1	10,00 SA1
VPE2	60,00 KT1
weight	0,218 KGM
text	KELOX-PROTEC CLIX wall bracket fitting with female thread
INTRNR	74122000
main material group	KELOX
material group	KELOX-PROtec pushfittings
code	KMP480X

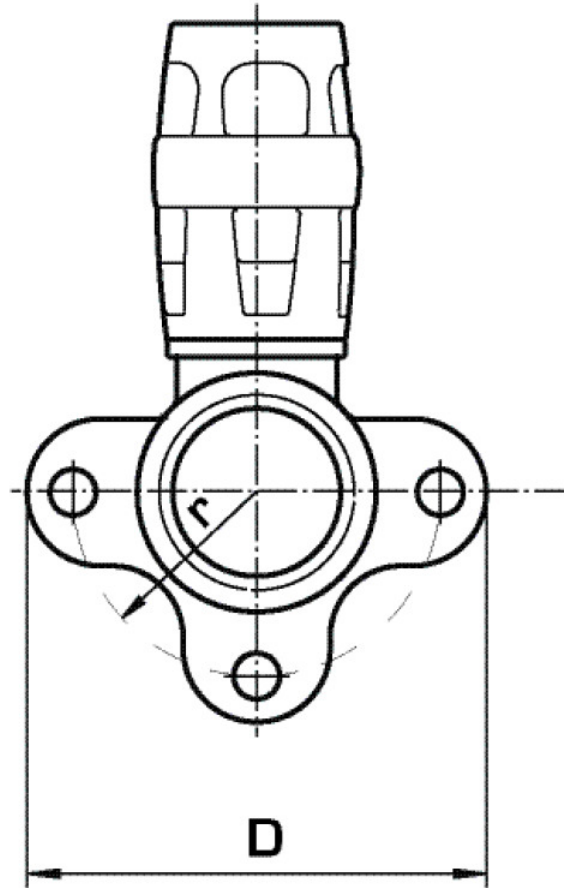
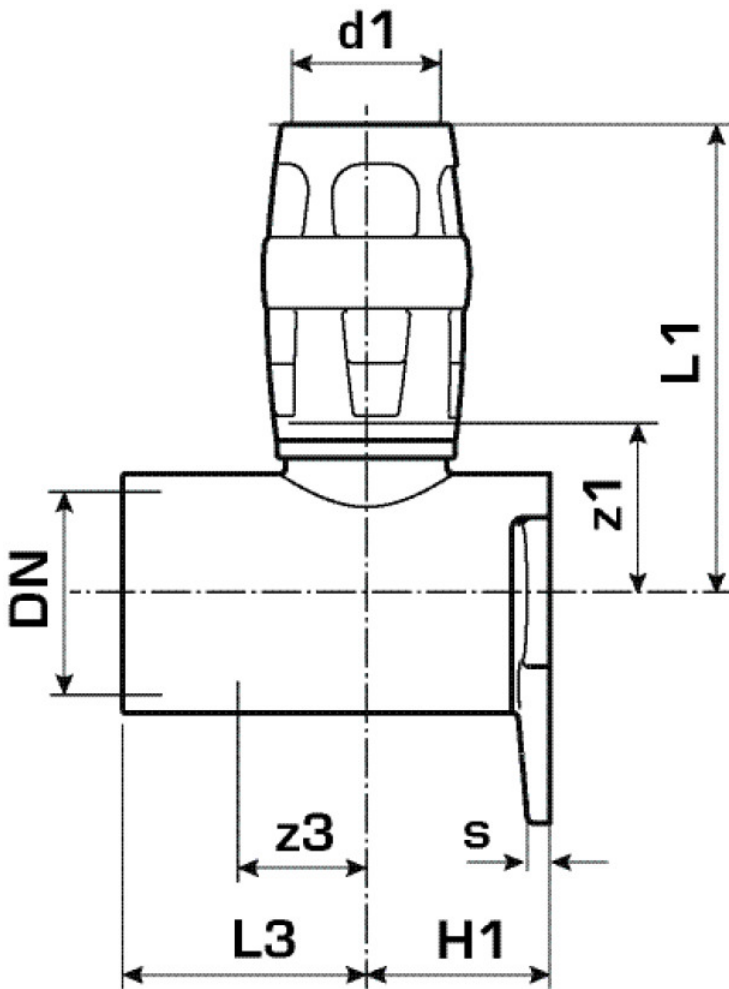

Art. No	label	d1 mm	L1 mm	L3 mm	z1 mm	z3 mm
730250D04	20x3/4"	20	55	29	22	11