

KELIT P

P7100 KELIT house infeed

3560700

Areas of application

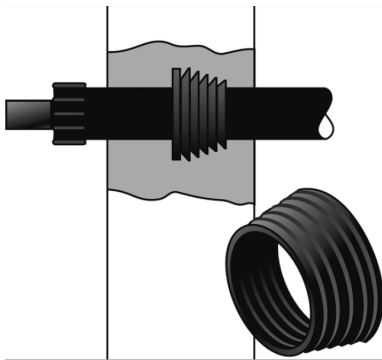

House lead-in or wall ducts (sealing ring) made of neoprene, for watertight pipe ducts with normal soil water. In the case of higher (pressing) groundwater, we recommend using PEX77 annular seals.

Specifications

Product information

casing DA	180-182
VPE1	1,00 STK
weight	0,500 KGM
text	KELIT house infeed
INTRNR	39174000
main material group	KELIT P
material group	KELIT P sleeves and accessories
code	P7100

Art. No

3560700



KE KELIT GmbH

A 4020 Linz, Ignaz-Mayer-Straße 17, Austria, Europe

PHONE +43 (0) 50 779 **E-MAIL** office@kekelit.com

www.kekelit.com