

KELEN

KE52 KELEN PP-RCT ferde ülék? szelep szerelvénycsatl. KE57 25-DN20

2670251

Felhasználási terület

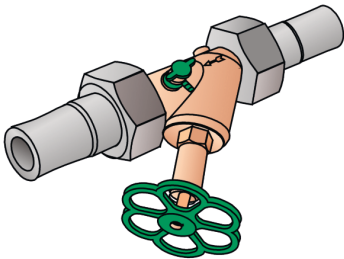

KELEN PP-RCT polifúziós hegeszt?idom, KE57 laposan tömít? szerelvénycsatlakozó-csavarzattal, „holttérmentes” fels? rész, EPDM-tömítéssel és leeresztéssel
A m?anyag aljzat és az EPDM-tömítés külön szállítható!

Engedélyek:



Specifikáció

Termékinformációk	
VPE1	1,00 SA1
VPE2	10,00 KT1
VPE3	40,00 KT2
VPE4	960,00 PAL
Tömeg	0,772 KGM
Szöveg	KELEN PP-RCT ferde ülék? szelep szerelvénycsatl. KE57
BELS?	84818079
Áruf?csoport	KELEN
Áruf?csoport	KELEN fém idomok
Kód	KE52

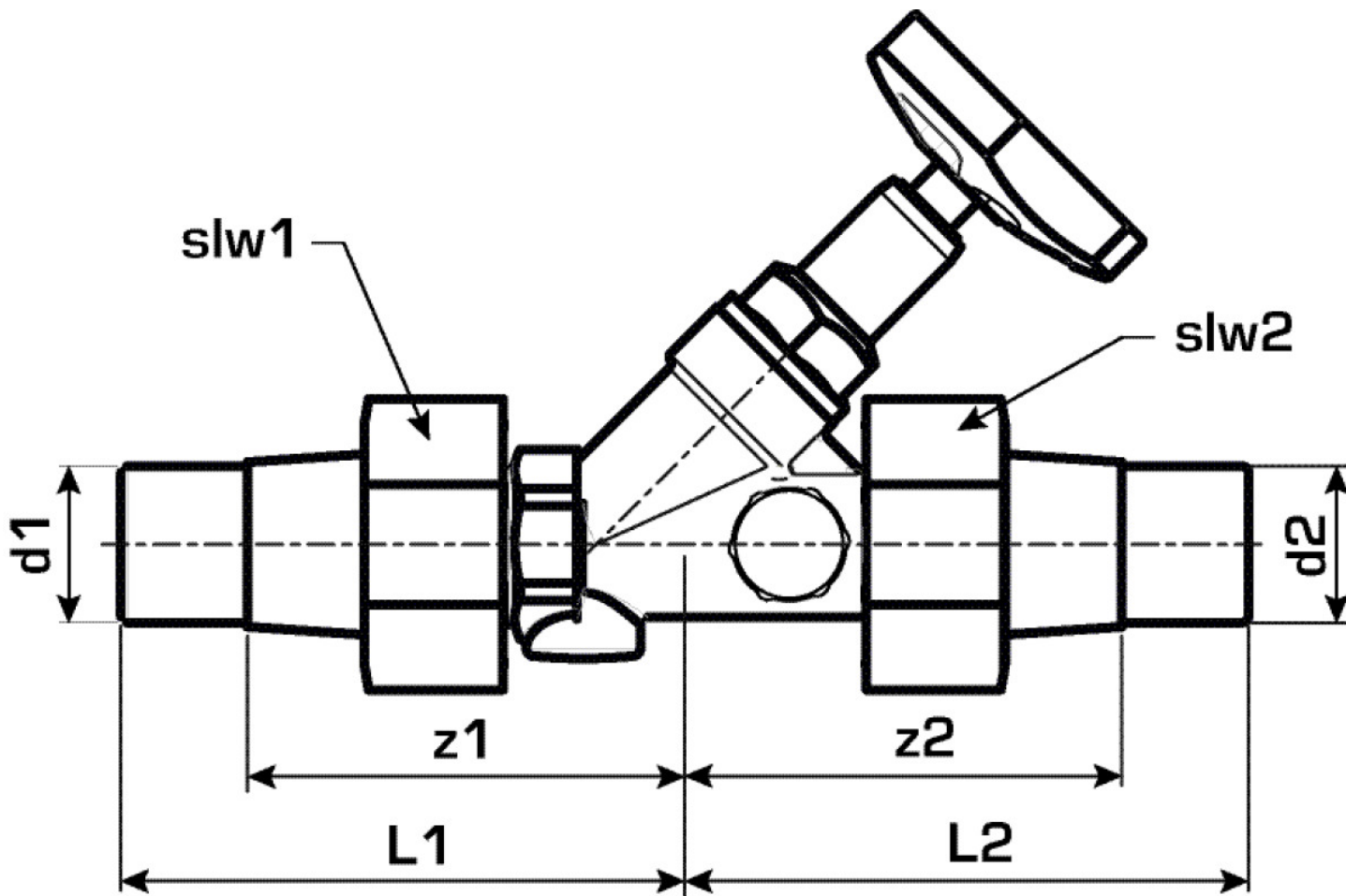

Cikkszám	Rajz	L1 mm	L2 mm	z1 mm	z2 mm	slw1	slw2
2670251	25-DN20	95	95	75	75	46	46