

KELOX_{FB}

KELOX manifold cabinet body 110 5-8 L: 690mm

9000610

Felhasználási terület

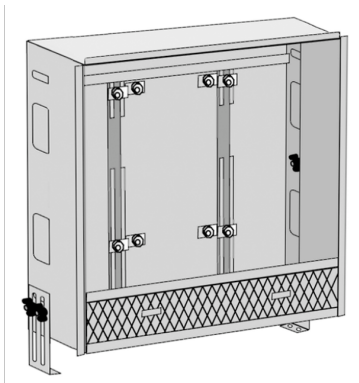

Sendzimir-galvanised universal steel plate cabinet; can be connected from below or at the side; height-adjustable feet; surface-or flush-mounted visible part can be retrofitted. Suitable for installing KM651 KELOX FB fixed value regulator set and KU590 industrial surface manifold. Space for straight or 90° connection set KM593E as well as KM591E 90° elbow is taken into account. Number of manifold outlets coordinated with KM590E and KMP590M KELOX FB brass manifold!

Plaster trim element below cabinet, Width: 120mm

Cabinet depth: 110mm

Installation height: 600mm above finished floor

Specifikáció

Termékinformációk

Szöveg

KELOX manifold cabinet body 110